

FLUID COILS



Heatcraft[®] heat transfer coils



CONTENTS AND NOMENCLATURE

Nomenclature.....	2
Standard Fluid Coils	3-4
Modu-coil Option.....	4
Booster Coils.....	4
Cleanable Coils.....	5-6
Fluid Construction	
Connections	7
Tube & Header Material.....	7
Headers.....	7
Casing.....	8
Tube Supports.....	8
Tubing.....	8
Fins	9
Coil Options	9
Piping Dimensions.....	10
Engineering	
Psychrometric Chart.....	11
Air Streams.....	11
BTU Chart	12
General Formulas	13
Terminology.....	13-14
Other Applications.....	15

NOMENCLATURE

5 W S 14 06 C 24.00 x 144.00

5 = Tube Outside Diameter

3 = 0.375"

4 = 0.500"

5 = 0.625"

W = Coil Type

W = Standard Fluid

M = 1 & 2 Row Splayed Header

B = Booster/Duct Mount

K = Cleanable Both Ends

P = Cleanable Supply End

Q = Cleanable Opp. Supply End

S = Circuiting

I = 1/6 serp

Q = 1/4 serp

E = 1/3 serp

H = 1/2 serp

G = 2/3 serp

L = 3/4 serp

S = 1 serp

C = 1 1/4 serp

P = 1 1/3 serp

M = 1 1/2 serp

D = 2 serp

T = 3 serp

F = 4 serp

B = skip tube

Booster

S = 1 circuit

D = 2 circuits

B = skip tube

14 = Fins Per Inch

06 = Rows Deep

C = Fin Design

A - flat (Al, Cu)

B - corrugated (Al, Cu)

C - sine wave (Al, Cu)

D - raised lance (Al) 3/8 and 1/2

F - flat (SS, CS)

G - corrugated (SS, CS)

H - sine wave (SS, CS, Al, Cu)

24.00 = Fin Height (in)

minimum of 6 inches

144.00 = Finned Length (in)

minimum of 6 inches

STANDARD FLUID COILS

Modine's design and production capabilities cover the complete range of HVAC&R market applications and fully respond to the most demanding clients' needs in terms of efficiency and energy saving.

Modine is an AHRI certified coil manufacturer participating in the AHRI Forced Circulation Air-Cooled and Air-Heating Coils Certification Program.

Fluid coils are typically used for air heating and air cooling applications in hot water and chilled water systems.

Heating coils used for comfort conditioning are typically one or two rows with some four row coils required for extreme loads. Modine offers three types of heating coils. The standard type "W" heating coils utilize a collection header on the end opposite the connections for 1 & 2 row coils. This collection header collects and redistributes the fluid in lieu of return bends. Type "M" 1 & 2 row coils are referred to as splayed header coils. One of the coil headers is moved outward away from the center of the fin pack with the use of adapter tubes. Type "M" coils use return bends for circuitry. The third type is booster or "B" type. Typically used in duct applications. These coils do not have headers and are thus limited by the amount of flow which they can handle without having excessive fluid velocities. Two standard circuits are available. The "S" circuit feeds one tube. The "D" circuit feeds two tubes and thus will handle higher flow rates than the "S" circuit.

Chilled water systems are found in most office buildings, hospitals, universities, or other commercial buildings. These systems generate chilled water which is circulated throughout the building to service various types of cooling coils. The term chilled water system is somewhat of a generic term because most systems have some form of freeze protective glycol mixed with the water. These glycols do decrease the coefficient of heat transfer for the water and need to be included in coil performance calculations. Use our Coil Calc software to determine your coil needs.

Figure 1 - Standard Coil Types

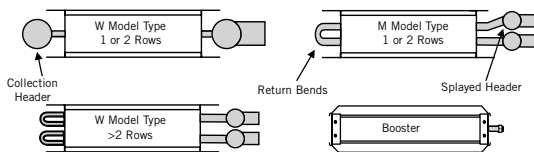

COIL TYPES

Fluid Coils - Our fluid coils are specifically designed for your particular application. Flexibility is built into our manufacturing processes, offering variations in fin type, fin density, circuitry arrangement, coil casing and materials of construction. Standard fluid type "W" coils utilize a collection header for one and two row applications and return bends for applications that require three or more rows. Type "M" coils are used for one and two row applications that require same end connections. For type "M" coils the supply and return headers are offset or "splayed." This orientation allows for the supply and return headers to be placed side by side. Booster coils, type "B," are also available for one and two row applications.

Modular Coils - Modular coils offer a replacement solution for cases where the space to maneuver is limited. A fluid coil built multiple modules allows a module to fit in elevators and tight spaces making the installation and transportation of a coil this big easier. Using a module coil might save expenses such as demolition/remodel and crane services, savings could also include reducing down time of different areas. A module coil is a fluid coil constructed in multiple parts. Note: the face area will be reduced by the thickness of the module plate. Modular coil limitations are similar to fluid coils. See table on page 3 for Modu-coil option. Since the split is done on the face of the coil, circuits that are offered for the different fluid coils are available for modular coils. Coil will have a header side and a return bend side. Opposite end connection coils are available depending on the circuit. Dimensions of the coil will follow standard Heatcraft design of a fluid coil adding 4 inches to the minimum required depth of the coil design.

Figure 2 - Same End Connections

Model	Rows
MS, ME	2
MH, MQ, MI	1, 2
WQ, WH, WL, WI	3, 4, 5, 6, 8, 10, 12
WS, WG, WE	4, 6, 8, 10, 12
WM, WC	3*, 4*, 5, 6, 8, 10, 12
WD	4*, 8, 12
WT	6*, 12
WT 2 1/2 Serp	5*, 10
WP	4*, 6, 8, 10, 12

*Left and Right Hand Only

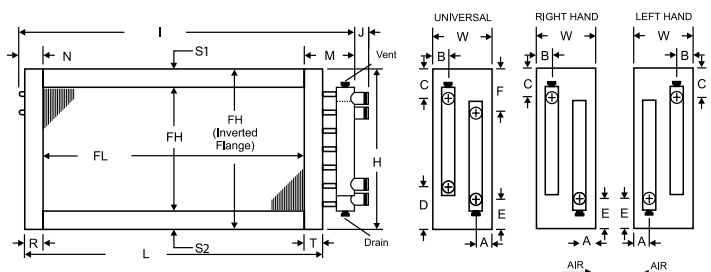

STANDARD FLUID COILS

Figure 3 - Opposite End Connections

Model	Rows
WE, WS	3, 5
WD	6, 10
WT	9

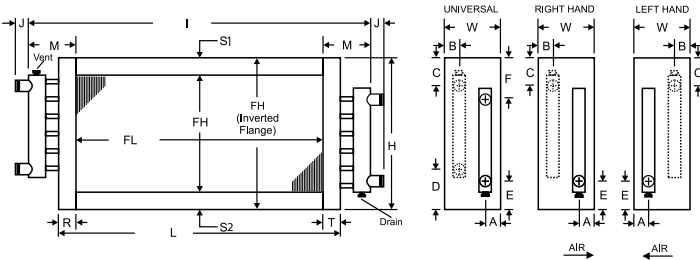

Figure 4 - Collection Header - Same End Connections

Model	Rows
WS	2
WB, WH, WQ	1, 2

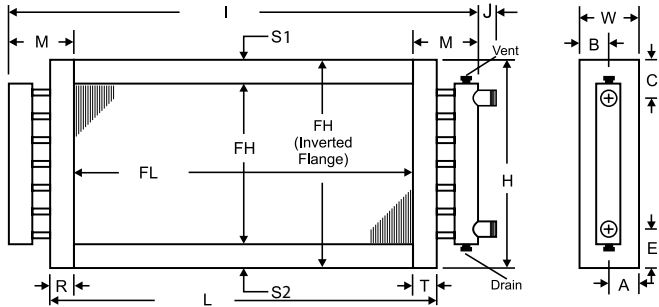
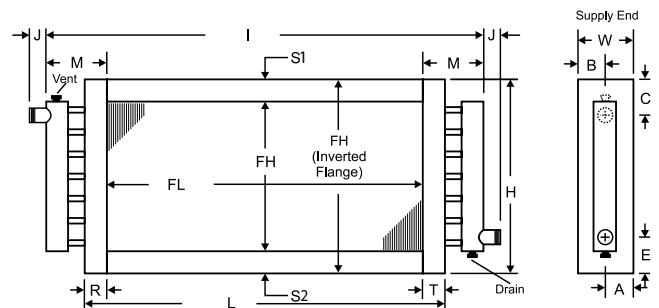

Figure 5 - Opposite End Connections

Model	Rows
WS	1
WD	2
WT	3



MODU-COIL OPTION

Coil Type	Rows
All Fluid	All

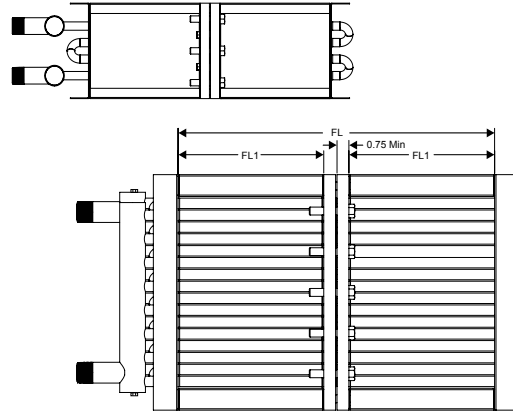

BOOSTER COILS

Table 2a - Booster "M" Dimensions

Coil Type	Connection	M Dim
BB/BS	< 1"	3.00
BB/BS/BD	= 1"	4.12
BD	< 1"	3.50

Figure 6 - Booster Coil - Slip & Drive shown

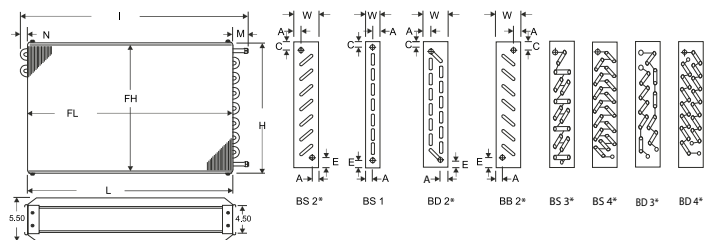

We also offer BD 1 Row Coils and opposite end BS 1 Row and BD 2 Row. There are some exceptions. Booster 3 and 4 Row are not available in Slip & Drive Casing.

CLEANABLE COILS

Cleanable Fluid Coils - We offer cleanable fluid coils for applications where mechanical cleaning of the internal surface of the tubes is needed. Our cleanable coils utilize a box-style head in lieu of cylindrical headers. The head contains baffles for circuiting and is removable for easy access to coil tubes.

Type "P" coils are cleanable from the connection end of the coil. Type "Q" coils are cleanable from the end opposite the connections. Type "K" coils are cleanable from both ends of the coil.

Cleanable tube fluid coils with 0.625 inch tubing are available with a minimum 0.035 tube wall, for applications where mechanical cleaning of the coil tubes is required. Our standard cleanable coils should only be used for operating pressures less than 100 psig. For higher pressures consult factory.

Figure 7 - Cleanable Coil Types

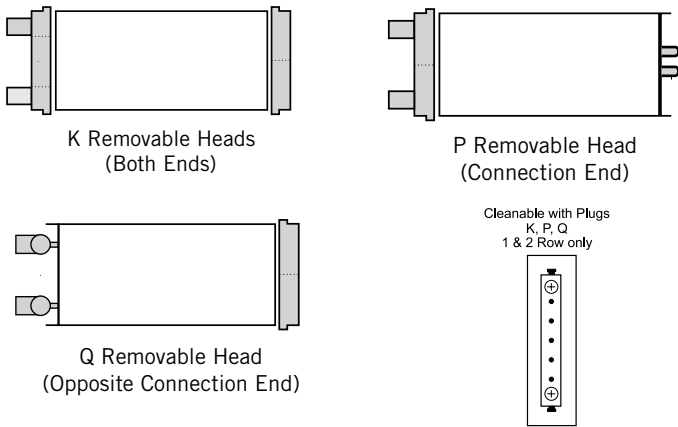

Note: The standard type "W" coils can be made cleanable by installing cleanable plugs for each tube. This is an alternative to the steel head plate design and has a higher working pressure.

Figure 8 - Collection Header with Plugs - Same End Connections

Model	Rows
KS	2
KH, KQ	1, 2
QS	2
QH, QQ	1, 2
PS	2
PH, PQ	1

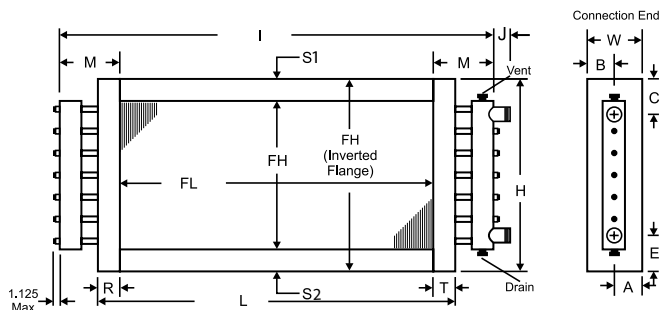
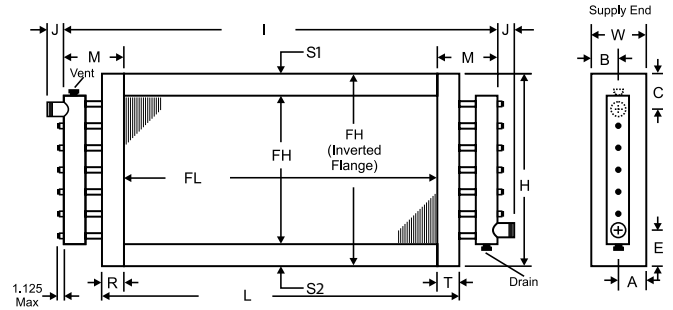

Figure 9 - Collection Header with Plugs - Opposite End Connections

Model	Rows
KS, PS, QS	1
KD, PD, QD	2



Model "K" coils have plugs on both ends (as shown above)
 Model "P" coils have plugs on the supply end only
 Model "Q" coils have plugs on the return end only

Figure 10 - Cleanable Both Ends - Same End Connections - Single, Double & Triple Serp

Model	Rows
KS	4, 6, 8, 10, 12
KD	4, 8, 12
KT	6, 12

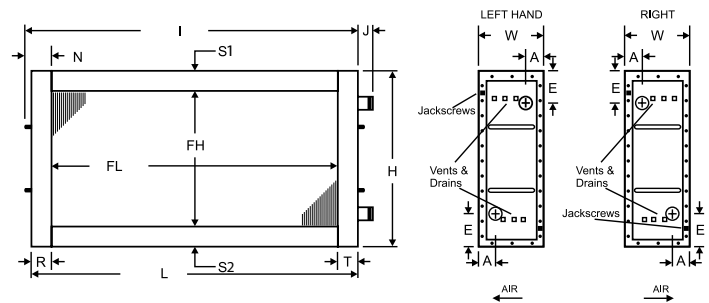
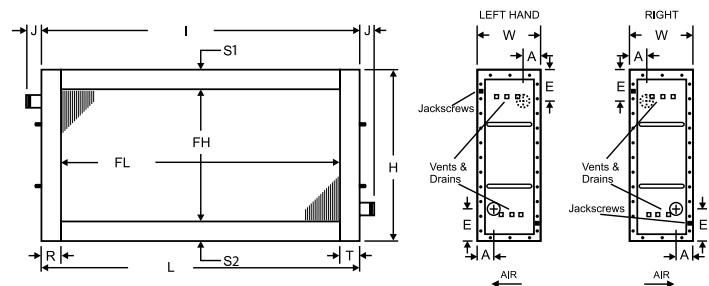

Figure 11 - Cleanable Both Ends - Opposite End Connections

Model	Rows
KD	6, 10



CLEANABLE COILS

Figure 12 - Cleanable Both Ends - Same End Connection - Half Serp

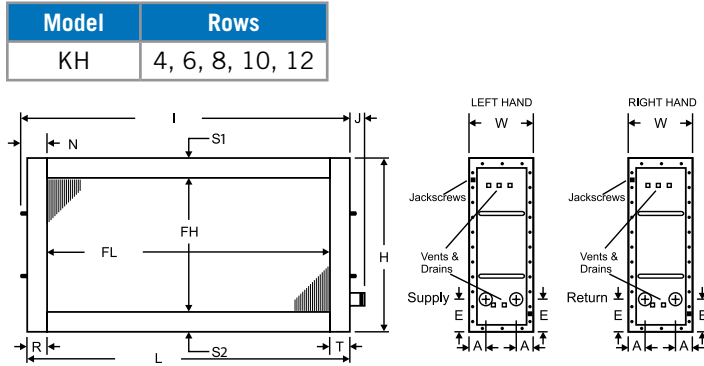

Figure 13 - Cleanable Opposite Supply End - Same End Connections - Single, Double & Triple Serp

Model	Rows
QD	4, 8, 12
QS	4, 6, 8, 10, 12
QT	6, 12

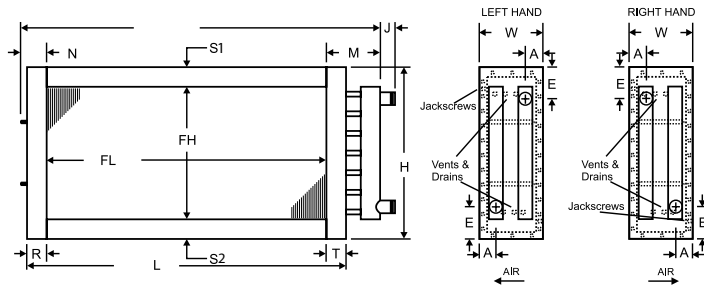

Figure 14 - Cleanable Opposite Supply End - Opposite End Connections

Model	Rows
QD	6, 10

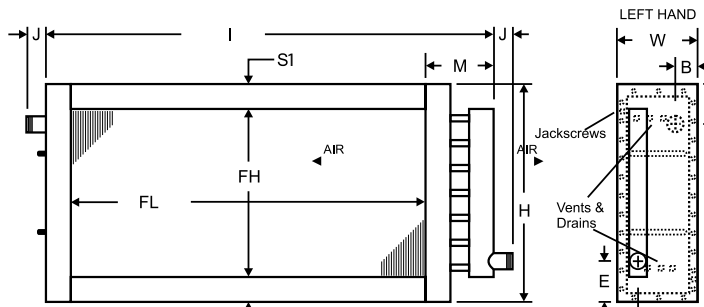

Figure 15 - Cleanable Opposite Supply End - Same End Connection - Half Serp

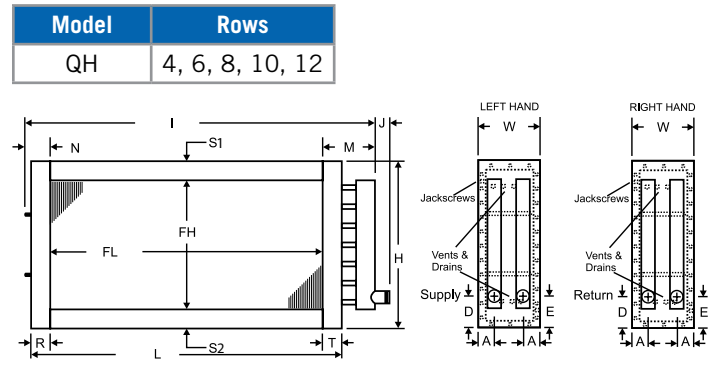

Figure 16 - Cleanable Supply End - Same End Connections

Model	Rows
PS	4, 6, 8, 10, 12
PD	4, 8, 12
PT	6, 12

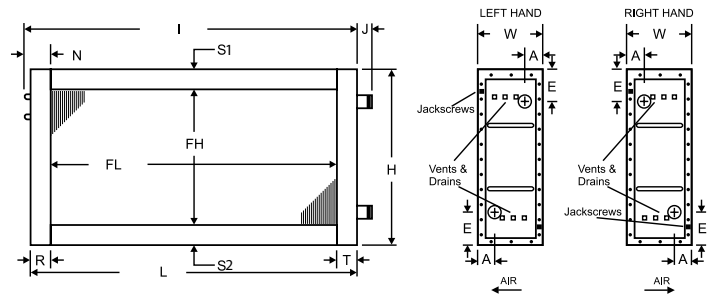
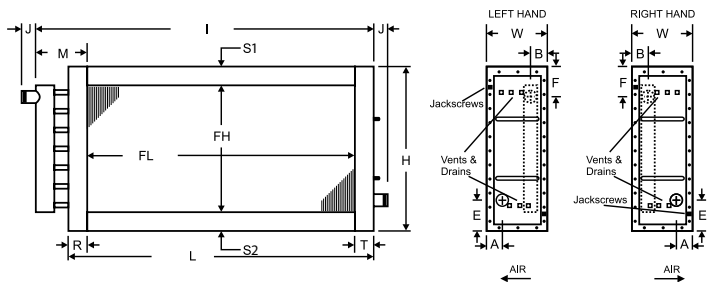

Figure 17 - Cleanable Supply End - Opposite End Connections

Model	Rows
PD	6, 10



FLUID CONSTRUCTION

CONNECTIONS

Connections are constructed of carbon steel, red brass, wrought copper, copper, cupronickel, or stainless steel material. Schedule 40 and 80 pipe sizes from 0.50 to 4.00 are available. Connection types are MPT, FPT, butt weld, victaulic or sweat. Screw thread, weld neck or slip on flanges can be added.

Supply connections are located at the bottom of the coil and the return connections are located at the top of the coil, unless stated otherwise.

Coil tube velocities, header velocity and other constraints may place limits below the maximums listed in the chart.

Coils with universal connection have 2 supply and 2 return connections. The coil is either left or right hand. This option is used when the coil hand is not available or if the coil is to be used as a backup for quick replacement of either a right or left hand coil. Using universal connections can cut inventory by providing the flexibility of one coil for either hand connections. Upon installation the extra connections are capped since they are not needed.

Table 6 - Material Options

Material
Copper Sweat UNS # 12200, ASTM B-75, with a H55 Temper
Stainless Steel 304L or 316L ASTM A 312 Sch 40 or Sch 80
Carbon Steel A53A Sch 40
Cupronickel UNS# C70600, 90/10, ASTM B-111
Admiralty Brass UNS # C444000, ASTM B-111, Type B

Figure 18 - Connection Location

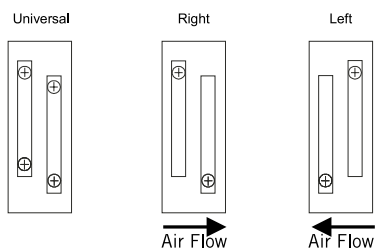

Table 7 - Connection Size vs. GPM

Conn Size	Max GPM	Conn Size	Max GPM
0.50	7.5	2.00	83.7
0.75	13.3	2.50	119.4
1.00	21.5	3.00	184.3
1.25	37.3	3.50	246.5
1.50	50.8	4.00	317.4

Based on standard Schedule 40 steel pipe.

Table 8 - Tube & Header Material

Coil Type	Tube Dia	Tube Matl	Tube Thickness	Max Std Operating Limits		
				PSIG	Temp	
W	0.375	CU	0.013, 0.016, 0.020, 0.025, 0.030	250	300°F	
	0.500	CU	0.016, 0.022, 0.030			
M	0.625	CU	0.020, 0.025, 0.035, 0.049	Consult Factory	Consult Factory	
		CN	0.020, 0.035, 0.049			
B	0.625	AB	0.049	Consult Factory	Consult Factory	
		SS	0.035, 0.049, 0.065			
K	0.625	CS	0.049, 0.065	Consult Factory	Consult Factory	
		CU	0.035, 0.049			
P	0.625	CN	0.035, 0.049	100	150°F	
		AB	0.049			
Q	0.625	SS	0.035, 0.049, 0.065	100	150°F	
		CS	0.035, 0.049, 0.065			
Modu-Coil	W	0.625	CU	0.035, 0.049	250	250°F
		CN	0.035, 0.049			
	M	0.625	AB	0.049	Consult Factory	Consult Factory
			SS	0.035, 0.049, 0.065		
	K	0.625	CS	0.049, 0.065	Consult Factory	Consult Factory
			CU	0.035, 0.049		
	P	0.625	CN	0.035, 0.049	100	150°F
			AB	0.049		
Q	0.625	SS	0.035, 0.049, 0.065	100	150°F	
		CS	0.035, 0.049, 0.065			

HEADERS

Headers are constructed from copper, cupro-nickel, carbon steel or stainless steel. End caps will be die-formed and installed on the inside diameter of the header such that the landed surface area is three times the header wall thickness.

When possible, intruded tube holes in the header allow an extra landed brazing surface for increased strength and durability. The landed surface area is three times the core tube thickness to provide enhanced header-to-tube joint integrity. All core tubes are evenly extended within the inside diameter of the header.

Material	Material Type	ASTM Rating
Copper	UNS 12200 Seamless Copper	ASTM B75 & ASTM B251
Cupronickel	Seamless 90/10 Cupronickel Alloy C70600	ASTM B111
Stainless Steel	Stainless Steel 304L & 316L, Sch-5 or Sch-40	ASTM-A312
Carbon Steel	Carbon Steel Sch-10	ASTM-A135A
Carbon Steel	Carbon Steel Sch-40	ASTM-A53A

FLUID CONSTRUCTION

END CAPS

End caps will be die-formed and installed on the inside diameter of the header such that the landed surface area is three times the header wall thickness.

BRAZED COPPER TUBES-TO-COPPER HEADER JOINT

Seamless copper tubes are brazed into heavy gauge seamless drawn copper headers. This combination of similar metals eliminates unequal thermal expansion and greatly reduces stress in the tube-header joint. When possible, intruded tube holes in the header allow an extra landed brazing surface for increased strength and durability. The landed surface area is three times the core tube thickness to provide enhanced header-to-tube joint integrity.

Figure 19 - Brazed Joint

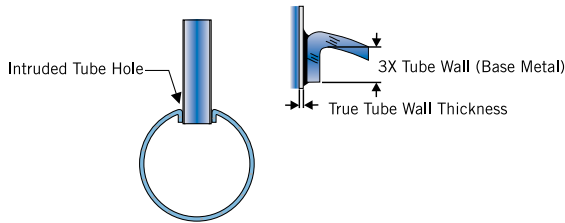

COIL CASE

Casings and end plates are made from 16-gauge galvanized steel unless otherwise noted. Double-flanged casings on top and bottom of finned height are to be provided, when possible, to allow stacking of the coils. All sheet metal brakes shall be bent to 90 degrees +/- 2 degrees and coils shall be constructed with intermediate tube support sheets fabricated from a heavy gauge sheet stock of the same material as the case, when possible.

Figure 20 - Coil Case

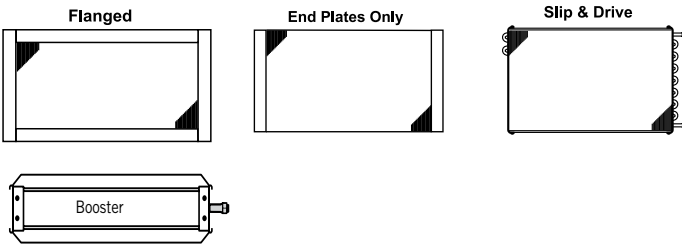

Table 9 - Coil Case Material

Material	Gauge		
	16	14	12
Galvanized Steel, ASTM A-924 and A-653	X	X	*X
Copper ASTM B-152	X	X	X
Aluminum Alloy-3003, Embossed Finish Alloy-5052, Mill Finish (0.125 only)	X	X	X
Stainless Steel 304L (or) 316L, 2B-Finish, ASTM A-240	X	*X	*X

*Not available in pierce and flare header plates

TUBE SUPPORTS

Table 10 - Tube Support Quantity

Finned Length (FL)	< 48	> 48 ≤ 96	> 96 ≤ 144	> 144
# of Tube Supports	0	1	2	4

TUBING

Tubing and return bends are constructed from seamless copper, cupro-nickel, admiralty brass, stainless steel or carbon steel tubing. Copper tube temper is light annealed with a maximum grain size of 0.040 mm and a maximum hardness of Rockwell 65 on the 15T scale. Tubes are mechanically expanded to form an interference fit with the fin collars. Unless otherwise specified, tubes will have a nominal thickness of 0.020 inch.

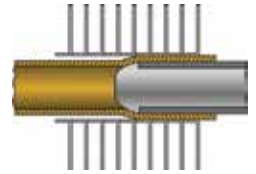

Table 11 - Tubing Material

Tubing Type	Connections	Tube O.D.	Tube Thickness
Copper	Carbon Steel, Red Brass, Copper Sweat	0.375	0.013, 0.016, 0.020, 0.025, 0.030
		0.500	0.016, 0.022, 0.030
		0.625	0.020, 0.025, 0.035, 0.049
Copper - Rifled	Copper Sweat	0.375	0.012, 0.016
		0.500	0.016
Cupronickel	Carbon Steel, Red Brass	0.625	0.020, 0.035, 0.049
Admiralty Brass	Carbon Steel, Red Brass	0.625	0.049
Stainless Steel	Stainless Steel	0.625	0.035, 0.049, 0.065
Carbon Steel	Carbon Steel	0.625	0.035, 0.049, 0.065

FLUID CONSTRUCTION

FINS

Coils are built of plate-fin type construction providing uniform support for all coil tubes. Coils are manufactured with die-formed aluminum, copper, cupro-nickel, stainless steel or carbon steel fins with self-spacing collars, which completely cover the entire tube surface, providing maximum heat transfer. Fins per inch limitations will be based on fin material and fin thickness.

Table 12 - Fin Material

Material	Fin Thickness (in.)			
	0.0060	0.0075	0.0095	0.0160
Aluminum	X	X	X	X*
Copper	X	X	X	X*
Cupro-nickel 90/10		X		
Stainless Steel		X	X	
Carbon Steel		X	X	

*0.625" A and B surface only

COIL OPTIONS

Vent and Drain Connections are standard on all fluid coils except booster-type coils, which do not have headers. The standard vent and drain connections are 0.5" female pipe thread with a hex head MPT plug. 0.5" male pipe connection is also available. The standard location for the vent and drain is on the end of the supply and return headers. For horizontal air flow with the headers standing vertically, the vent is located on the top of the return header in the end cap. The drain connection is located on the bottom of the supply header in the end cap. Note that one and two row heating coils with a collection header, type "W", will have both connections on one header for same end connection coils.

The vent and drain connections can be placed on the face of the header facing parallel to the coil tubes; these connections can be extended to the same length as the supply and return connections for easy access. Another option is to locate the vent and drain connections on the side of the coil headers facing outward, with the drain connection facing in the direction of the air flow, and the vent connection facing upstream from airflow. This is usually done for vertical airflow applications. Vents on the top of the coil allow purging of air from the coil. Periodic venting is required to maintain proper coil performance. Drains located at the bottom of the coil provide freeze protection in cold climates and for service drainage.

Figure 21 - Vent and Drain

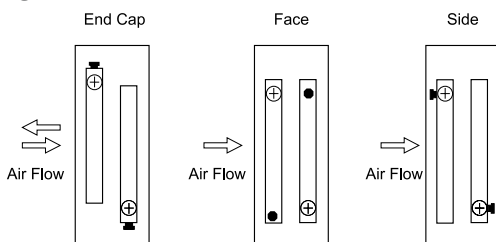

Coil Circuitry is a key parameter of coil performance. Proper selection of coil circuitry is needed to attain correct coil tube velocity and avoid excessive fluid pressure drop. Modine offers a variety of standard circuitry arrangements. Our computer selection software Coil Calc will automatically select the correct circuit pattern for the given design conditions. Specially designed coil circuits are available for applications where standard circuitry does not meet your performance requirements.

Brass Turbospirals can be installed within the coil tubes. These turbospirals increase the amount of turbulence in the fluid flow and thus increase the rate of heat transfer. This allows for an increase in capacity without affecting the external coil dimensions or increasing air pressure drop. Note that the increase in turbulence will also increase the fluid pressure drop.

Cleanable Plugs can be installed on standard water coils to allow for mechanical cleaning of the internal surface of the coil tubes. The plugs can be installed on one end or both ends as needed.

These brass plugs offer a more economical option to attain cleanability as compared to the removable steel baffle plate design, (Heatcraft coil type 'P', 'Q' or 'K'). The cleanable plugs generally require more labor to clean than the steel header box design.

Coatings can be applied to the entire external coil surface after fabrication. These coatings are typically applied for additional protection from corrosion or cosmetic reasons. Modine offers two options for coating of coils. ElectroFin® E-Coat is a water-based, flexible epoxy polymer coating process engineered specifically for HVAC/R heat transfer coils. It's excellent corrosion and UV resistance make it suitable for coastal environments. Modine Insitu® is a water-based (solvent free) and water-reducible synthetic flexible polymer coating engineered specifically for HVAC/R heat transfer coils and components. Modine Insitu® is applied at our facilities or can be applied on-site after the units have been manufactured.

Drain Pans are manufactured with 304L or 316L stainless steel or 16 gauge galvanized steel. It features welded corners and is built per ASHRAE standard.

Mist Eliminators allow for higher-than-normal air flow without concern of moisture carry-over. It allows for reduction of the face size, thus lowering the cost of the coil, with a minimal increase in air pressure drop. It mounts directly to the discharge of the cooling coil.

MARC (Modular Auxiliary Removable Coil) unit replaces existing coil sections. The coil is removable through an access panel. It can be supplied with galvanized or stainless-steel casing, a stainless-steel drain pan and with single or double-wall construction. This unit can be used for auxiliary/supplementary heating/cooling, as well as to add to make-up air units. An optional internal filter rack with an access door is also available.

FLUID CONSTRUCTION

SCHEDULE 40 PIPE DIMENSIONS

Table 14 - Schedule 40

Pipe Size (in.)	External Dia. (in.)	Internal Dia. (in.)	Internal Area (in ²)	Volume ft ³ /ft	Weight lbs/ft	Threads per inch
0.250	0.540	0.364	0.104	0.00072	0.424	18
0.375	0.675	0.493	0.191	0.00133	0.564	18
0.500	0.840	0.622	0.304	0.00211	0.850	14
0.750	1.050	0.824	0.533	0.00370	1.130	14
1.000	1.315	1.049	0.864	0.00600	1.678	11.50
1.500	1.900	1.610	2.038	0.01414	2.717	11.50
2.000	2.375	2.067	3.355	0.02330	3.652	11.50
2.500	2.875	2.469	4.788	0.03250	5.793	8
3.000	3.500	3.068	7.393	0.05134	7.575	8
3.500	4.000	3.548	9.886	0.06866	9.109	8
4.000	4.500	4.026	12.730	0.088400	10.790	8

Note: Pipe threads listed are N.P.T.

SCHEDULE 80 PIPE DIMENSIONS

Table 15 - Schedule 80

Pipe Size (in.)	External Dia. (in.)	Internal Dia. (in.)	Internal Area (in ²)	Volume ft ³ /ft	Weight lbs/ft	Threads per inch
0.250	0.540	0.302	0.072	0.00050	0.535	18
0.375	0.675	0.423	0.141	0.00098	0.738	18
0.500	0.840	0.546	0.234	0.00163	1.000	14
0.750	1.050	0.742	0.433	0.00300	1.470	14
1.000	1.315	0.957	0.719	0.00500	2.170	11.50
1.500	1.900	1.500	1.767	0.01227	3.650	11.50
2.000	2.375	1.939	2.953	0.02051	5.020	11.50
2.500	2.875	2.323	4.238	0.02943	7.660	8
3.000	3.500	2.900	6.605	0.04587	10.300	8
3.500	4.000	3.364	8.888	0.06172	12.500	8
4.000	4.500	3.826	11.497	0.07980	14.900	8

Note: Pipe threads listed are N.P.T.

ENGINEERING

PSYCHROMETRIC CHART

The psychrometric chart provides a graphical representation of the thermodynamic properties of moist air. The chart correlates various properties, which are interrelated. The properties shown on the chart are the following: dry bulb, wet bulb, relative humidity, enthalpy, humidity ratio, dew point and specific volume. If you are given any two of these properties along with barometric pressure it is possible to determine the other properties using the chart once your conditions are correctly plotted.

Example: Given a dry bulb temperature of 80°F, 50% relative humidity at standard atmospheric pressure determine the wet bulb, enthalpy, humidity ratio, and dew point using the psychrometric chart and a straight edged ruler.

The correct answers are wet bulb = 66.7°F, enthalpy= 31.25 Btu/lb. dry air, humidity ratio = .011, dew point = 59.7°F.

By plotting the beginning and ending conditions of a moist air system, you can visually verify the changes, which are occurring between these two points. Draw a straight line between the initial and the ending positions on the chart. Clearly mark which point is beginning and which is ending. Moving from the initial to final condition will give a direction of movement. This direction identifies what type of process has occurred. See the outline of the psychrometric chart below.

Figure 22 - Psychrometric Chart

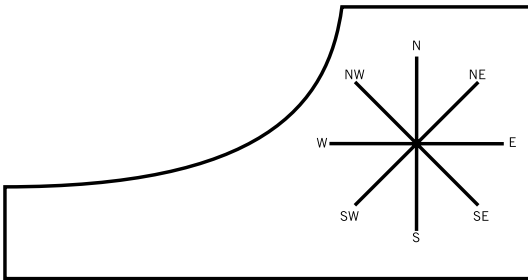

Table 16 - Regional Application

Movement	Process Occurring	Typical Application
East	Sensible Heating Only*	Comfort Heating
Northeast	Heating with Humidification	Comfort Heating & Increasing Moisture
North	Humidification Only	Only Increasing Moisture
Northwest	Evaporative Cooling	Cooling in Very Low Humidity Areas
West	Sensible Cooling Only	Cooling without Moisture Removal
Southwest	Cooling with Dehumidification*	Comfort Cooling & Moisture Removal
South	Dehumidification Only	Moisture Removal

* Most common processes which occur for comfort heating and cooling.

COMBINING TWO ADIABATIC, EQUAL PRESSURE AIR STREAMS

This is a common problem in air duct systems. This situation occurs when outside air is being introduced into the return air ductwork. Here you have two different entering air conditions that combine to form a single state. Using a graphical representation on the psychrometric chart can solve this problem. This process assumes that both airstreams are at approximately the same pressure. Below is an example of how to solve this problem.

Example: Given two airstreams

- 400 CFM of air at 95/78°F (Dry bulb/Wet bulb)
- 3600 CFM of air at 80/67°F (Dry bulb/Wet bulb)

Find the resulting combined air stream conditions

Figure 23 - Air Streams

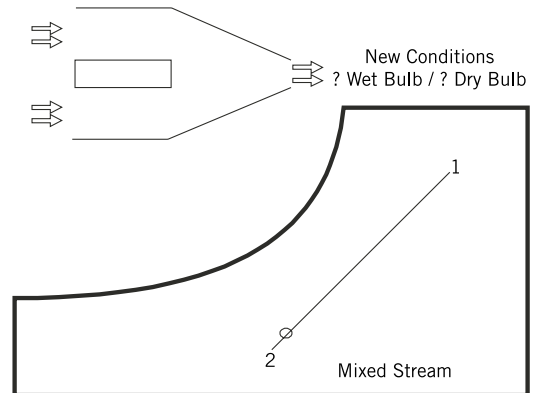

- Plot both conditions on the psychrometric chart and identify the points.
- Draw a line between the points. The final mixed air stream's state lies on this line.
- Calculate the volumetric ratio of the dry air masses. To do this add the airflows together, and then divide the larger airflow by this total.
- With a ruler measure the straight-line length between the two points. Multiply this length by the volumetric ratio to get the distance you must travel along this line from the smaller airflow point.

$$3600 \text{ CFM} + 400 \text{ CFM} = 4000 \text{ CFM Total}$$

$$3600 \text{ CFM} / 4000 \text{ CFM} = 0.90$$

The resulting mixed air stream is 4000 CFM at approx. 82/68°F (dry bulb/wet bulb).

Note: The resulting point plotted on the connecting line will be closest to the point representing the larger of the two airflows. If the airflow were equal the center point on the line would determine the resulting combined entering air conditions.

ENGINEERING

TOTAL HEAT (ENTHALPY)

Table 17 - Heat Content (BTU) of 1 lb. of Dry Air Saturated with Water Vapor† (Standard atmospheric pressure 29.921" HG)

WET BULB°F*	TENTHS OF DEGREES									
	.0	.1	.2	.3	.4	.5	.6	.7	.8	.9
35	13.01	13.05	13.09	13.14	13.18	13.22	13.27	13.31	13.35	13.39
36	13.44	13.48	13.52	13.57	13.61	13.66	13.70	13.74	13.79	13.83
37	13.87	13.92	13.96	14.01	14.05	14.10	14.14	14.19	14.23	14.27
38	14.32	14.36	14.41	14.45	14.50	14.54	14.59	14.63	14.68	14.73
39	14.77	14.82	14.86	14.91	14.95	15.00	15.05	15.09	15.14	15.18
40	15.23	15.28	15.32	15.37	15.42	15.46	15.51	15.56	15.60	15.65
41	15.70	15.74	15.79	15.84	15.89	15.93	15.98	16.03	16.08	16.12
42	16.17	16.22	16.27	16.32	16.37	16.41	16.46	16.51	16.56	16.61
43	16.66	16.71	16.75	16.80	16.85	16.90	16.95	17.00	17.05	17.10
44	17.15	17.20	17.25	17.30	17.35	17.40	17.45	17.50	17.55	17.60
45	17.65	17.70	17.75	17.80	17.85	17.91	17.96	18.01	18.06	18.11
46	18.16	18.21	18.26	18.32	18.37	18.42	18.48	18.52	18.58	18.63
47	18.68	18.73	18.79	18.84	18.89	18.95	19.00	19.05	19.10	19.16
48	19.21	19.26	19.32	19.37	19.43	19.48	19.53	19.59	19.64	19.70
49	19.75	19.81	19.86	19.92	19.97	20.03	20.08	20.14	20.19	20.25
50	20.30	20.36	20.41	20.47	20.52	20.58	20.64	20.69	20.75	20.81
51	20.86	20.92	20.98	21.03	21.09	21.15	21.21	21.26	21.32	21.38
52	21.44	21.49	21.55	21.61	21.67	21.73	21.79	21.84	21.90	21.96
53	22.02	22.08	22.14	22.20	22.26	22.32	22.38	22.44	22.50	22.56
54	22.61	22.68	22.74	22.80	22.86	22.92	22.98	23.04	23.10	23.16
55	23.22	23.28	23.34	23.41	23.47	23.53	23.59	23.65	23.72	23.78
56	23.84	23.90	23.97	24.03	24.10	24.16	24.22	24.29	24.35	24.42
57	24.48	24.54	24.61	24.67	24.74	24.80	24.86	24.93	24.99	25.06
58	25.12	25.19	25.25	25.32	25.38	25.45	25.52	25.58	25.65	25.71
59	25.78	25.85	25.92	25.98	26.05	26.12	26.19	26.26	26.32	26.39
60	26.46	26.53	26.60	26.67	26.74	26.80	26.87	26.94	27.01	27.08
61	27.15	27.22	27.29	27.36	27.43	27.50	27.57	27.64	27.71	27.78
62	27.85	27.92	27.99	28.07	28.14	28.21	28.28	28.35	28.43	28.50
63	28.57	28.64	28.72	28.79	28.87	28.94	29.01	29.09	29.16	29.24
64	29.31	29.38	29.46	29.53	29.61	29.68	29.76	29.83	29.91	29.98
65	30.06	30.16	30.21	30.29	30.37	30.44	30.52	30.60	30.68	30.75
66	30.83	30.91	30.99	31.07	31.15	31.22	31.30	31.38	31.46	31.54
67	31.62	31.70	31.78	31.86	31.94	32.02	32.10	32.18	32.26	32.34
68	32.42	32.50	32.59	32.67	32.75	32.83	32.92	33.00	33.08	33.17
69	33.25	33.33	33.42	33.50	33.59	33.67	33.75	33.84	33.92	34.00
70	34.09	34.18	34.26	34.35	34.43	34.52	34.61	34.69	34.79	34.86
71	34.95	35.04	35.13	35.21	35.30	35.39	35.48	35.57	35.65	35.74
72	35.83	35.92	36.01	36.10	26.19	36.28	36.38	36.47	36.56	36.65
73	36.74	36.83	36.92	37.02	37.11	37.20	37.29	37.38	37.48	37.57
74	37.66	37.75	37.85	37.94	38.04	38.13	38.23	38.32	38.42	38.51
75	38.61	38.71	38.80	38.90	39.00	39.09	39.19	39.28	39.38	39.47
76	39.57	39.67	39.77	39.87	39.98	40.07	40.17	40.27	40.37	40.47
77	40.57	40.67	40.77	40.87	40.97	41.07	41.18	41.28	41.38	41.48
78	41.58	41.68	41.79	41.89	42.00	42.10	42.20	42.31	42.41	42.52
79	42.62	42.73	42.83	42.94	43.05	43.15	43.26	43.37	43.48	43.58
80	43.69	43.80	43.91	44.02	44.13	44.23	44.34	44.45	44.56	44.67
81	44.78	44.89	45.00	45.12	45.23	45.34	45.45	45.56	45.68	45.79
82	45.90	46.01	46.13	46.24	46.36	46.47	46.58	46.70	46.81	46.93
83	47.04	47.16	47.28	47.39	47.51	47.63	47.75	47.87	47.98	48.10
84	48.22	48.34	48.46	48.58	48.70	48.82	48.95	49.07	49.19	49.31
85	49.43	49.55	49.68	49.80	49.92	50.04	40.17	50.29	50.41	50.54

*Use wet bulb temperature only in determining total heat.

†Compiled from data in ASHRAE Handbook of Fundamentals 1981.

ENGINEERING

GENERAL FORMULAS

TOTAL BTUH (Air Cooling)

Total BTUH = $4.5 \times \text{SCFM} \times (\text{Total Heat Ent. Air} - \text{Total Heat Lvg. Air})$

Where $4.5 = \text{Density Std. Air} \times \text{Min./Hr.}$
Density Std. Air = 0.075 lbs./cu. ft.
Min./hr. = 60

SENSIBLE BTUH (Air Cooling)

Sensible BTUH = $1.08 \times \text{SCFM} \times (\text{Ent. Air DB} - \text{Lvg. Air DB})$

Where $1.08 = (\text{Specific heat of air}) \times (\text{Minutes/Hr.}) \times \text{Density Std. Air}$
Specific heat = 0.24 btu/lb.F
Min./hr. = 60
Density Std. Air = .075 Lbs./cu. ft.

TOTAL BTUH (Air Heating)

Total BTUH = $1.08 \times \text{SCFM} \times (\text{Lvg. Air DB} - \text{Ent. Air DB})$

Where $1.08 = (\text{Specific heat}) \times (\text{Minutes/Hr.}) \times \text{Density Std. Air}$
Specific heat = 0.24 btu/lb.F
Min./hr. = 60
Density Std. Air = 0.075 Lbs./cu. ft.

TOTAL BTUH (Water Side)

Total BTUH = $500 \times \text{GPM} \times (\text{Lvg. Water Temp Ent. Water Temp})$

Where $500 = \text{Lbs./Gal.} \times \text{Min./Hr.} \times \text{Specific heat water}$
Lbs./gal. = 8.33
Min./hr. = 60
Specific heat = 1 btu/lb.F

SENSIBLE TOTAL RATIO

S/T Ratio = Sensible BTUH \div Total BTUH

LEAVING AIR TEMPERATURE (heating)

Lvg Air Temp. = Ent. Air Temp. + (Sensible BTUH \div (1.08 x SCFM))

LEAVING AIR TEMPERATURE (cooling)

Lvg Air Temp. = Ent. Air Temp. - (Sensible BTUH \div (1.08 x SCFM))

FACE AREA

FA (Sq. Ft.) = (Fin Height x Finned Length) \div 144

FACE VELOCITY (FPM)

FPM = SCFM \div Face Area (sq. ft.)

MBH PER SQUARE FOOT OF FACE AREA

MBH/Sq. Ft. = Total BTUH \div (Face Area (Sq. Ft.) x 1000)

WATER VELOCITY

FPS = (0.0022 x GPM) / (CS x # of circuits)
CS = $0.785 \times (D-2t)^2$
(where D = tube outside diameter
t = tube thickness)

NUMBER OF CIRCUITS

for: 5A, 5B, 5C, 4H (FH \div 1.5) x Serpentine
for: 4A, 4B, 4C (FH \div 1.25) x Serpentine
for: 3A, 3B, 3C, 3D (FH \div 1.00) x Serpentine
for: 3H (FH \div 1.25) x Serpentine

Standard Conditions:

Temperature = 70°F
Pressure = 14.69 psi
Density = 0.075 lb/ft³

TERMINOLOGY

Psychrometric Chart is a key tool in heat transfer calculations involving moist air. This graphic representation reveals the properties of air at various temperatures and moisture levels. It is used for load calculations for heating, cooling, humidification, dehumidification and various combinations thereof. Refer to "utilizing the psychrometric chart" section for further details.

Enthalpy Chart is a quick reference aide to find enthalpy values for given wet bulb temperature. Most often used to calculate cooling with dehumidification loads.

Dry Bulb Temperature is the actual temperature that a dry thermometer will read exposed to an airstream.

Wet Bulb Temperature refers to the temperature attained from a wet sensing bulb exposed to a moving air stream. This temperature, along with the dry bulb reflect the amount of water vapor present in this air stream.

Sensible Heat is the amount of heat transfer which occurs due to changes in dry bulb temperature only. Heat transfer without any addition of moisture or condensation of water vapor.

Latent Heat applies to the heat that is released when water vapor surpasses it's saturation point and condenses. Sometimes referred to as "hidden heat". In cooling coil applications, this heat must be factored into load calculations.

ENGINEERING

TERMINOLOGY CONTINUED

Total Heat is the sum of the heat content of the dry air (sensible) and moist air (latent) components in an air system. (total heat=sensible heat + latent heat)

Saturation is a condition of equilibrium(stability) when a given air space holds the maximum amount of moisture it can before water vapor condenses. This can be viewed as the fence between 100% humidity and the onset of condensation. The temperature at which this condition exists for a given air space is called the saturation temperature or dew point.

Face Area refers to the actual heat transfer surface, not overall dimensions. Face area is determined by multiplying fin height by finned length. This will give you face area in square inches, divide by 144 to convert square inches to square feet of face area.

Face Velocity is the speed of the air across the face of coil. Face velocity is a very important factor of coil performance. To compute you must know coil face area (square feet) and air flow in cfm (cubic feet per minute). Face velocity (feet per minute) is equal to air flow (cfm) divided by coil face area (square feet). Typical face velocities for heating are 600 to 1000 feet per minute. Cooling coils are generally limited to no more than 550 feet per minute due to condensate blowing off of fins and being evaporated back into air stream.

Relative Humidity is typically expressed as a percentage, this term expresses the ratio of water vapor in air to saturated air at the same temperature and pressure. Air, at it's saturation point, has 100% relative humidity.

Fouling Factor is a measure of the degree to which heat transfer is blocked due to scaling of surfaces. These factors may be used on air side or fluid side to adjust performance calculations to compensate for this loss.

GPM is the total coil flow rate in gallons per minute.

Number of Tubes Fed is the number of tubes coming off the header and feeding into the coil, or may also be determined by multiplying the # of tubes high by the coil circuit ratio.

Fluid (Tube) Velocity is often expressed in feet per second identifies the speed of the fluid through the coil tubes. Typical ranges for velocity are between 1 and 6 feet per second. Velocities below one foot per second reduce heat transfer by not attaining all the benefits of turbulent flow. Velocities above 6 feet per second can cause such friction on the inner tube wall that deterioration can occur, causing premature failure. Specific conditions of service should be specified for applications exceeding 6 feet per second tube velocity.

Fluid Pressure Drop is the reduction in pressure as the fluid passes through the coil. As the fluid passes into the coil header and distributes through the coil tubes, frictional forces reduce the pressure of the fluid. A given coil fluid pressure drop can be determined by measuring fluid pressure at coil inlet and subtracting the pressure measured at the coil outlet.

Serpentine Ratio ("circuit ratio") is an important design parameter for fluid coil performance which describes the fluid path through the tubes of the coil. It is defined by the total number of coil tubes feed divided by the number of tubes high in one row of the coil. Proper selection of this ratio matches coil performance and pressure drop limitations to system requirements.

Number of Coil Passes is directly related to the serpentine ratio. The number of coil passes refers to the number of times the fluid passes across the coil finned length. This can be calculated by inverting the circuit ratio, take 1 and divided it by the ratio, and multiplying by the number of rows. Calculating the number of passes also tells you if the coil will have opposite end connections. If the number of passes is odd the coil will have opposite end connections; if it is even the coil will have same end connections.

Example:

6 row double circuit coil
a double circuit coil has a circuit ratio of 2
 $1 \div 2 \times 6 \text{ rows} = 3 \text{ passes}$
3 is odd thus opposite end connections will occur.

Coil Hand determination is key to attaining performance in multi-row coils. Coil hand is determined when facing into the finned area of the coil in direction of air flow. If connections are on the right side the coil is right handed; if connections are on left side the coil is left handed. Coils with opposite end connections are based on supply connection location.

Counterflow is the preferred piping arrangement for coils, especially multi-row fluid coils. Proper selection of coil hand assures that counterflow piping is attained. The heat transfer media travels in the opposite direction of airflow as it moves from row to row. Failure to properly select coil hand connection on multi-row coils will result in parallel flow (non-counter flow) and will greatly reduce performance in cooling applications where moisture is removed.

OTHER APPLICATIONS

Picture 1 - M.A.R.C. unit



M.A.R.C. (Modular Auxiliary Removable Coil)

- Replaces existing coil section
- Removable coil through access panel
- Galvanized or stainless steel casing
- Modular unitary construction
- Insulated (single wall or double wall)
- Stainless steel drain pan
- Auxiliary/supplemental heating or cooling
- Add heating or cooling to make-up air unit
- Replaces existing coil section
- Internal (vertical) 2" and 4" filter rack option

Picture 2 - Drain Pan



Drain Pans

- 304L, 316L stainless steel and 16 gauge galvanized steel
- Lead Time - 10 working days
- Designed per customer's drawing



For more information, please contact:

Modine Grenada LLC
Grenada, MS, USA
Phone +662 229 4000
Fax +662 229 4212



Modine Grenada LLC
Tel: 800-225-4328
Fax: 662-229-4212
Grenada, MS
Email: coils@modine.com